

GKB OPHTHALMICS LTD ISO 9001:2015 CERTIFIED	TECHNICAL DATA SHEET (PLASTIC)	Doc. No	GKB/O/P/CR-SFB/21
		Issue No.	07
		Issue Date.	11-5-2017
SEMI-FINISHED CR-39 LENSES			
RI 1.498	FLAT TOP 28 BIFOCAL (D28)		70 MM

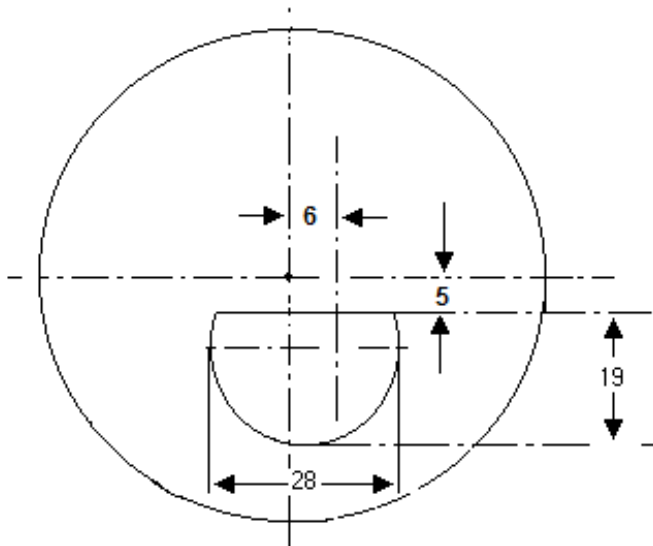

PRODUCT RANGE

BASE (dpt)	True curve (dpt)	CONVEX RADIUS (mm)	RCC (dpt)	C.T (mm)	E.T (mm)
2.25	2.13	234.10	-6.25	6.00	11.20
4.25	3.96	125.60	-6.25	6.50	9.25
6.25	5.89	84.60	-6.25	7.30	7.50
8.25	7.81	63.80	-6.25	9.30	6.80

POWER RANGE

BASE (dpt)	ADDITION (dpt)													
	0.75	1.00	1.25	1.50	1.75	2.00	2.25	2.50	2.75	3.00	3.25	3.50	3.75	4.00
2.25	*	*	*	*	*	*	*	*	*	*	*	*	*	*
4.25	*	*	*	*	*	*	*	*	*	*	*	*	*	*
6.25	*	*	*	*	*	*	*	*	*	*	*	*	*	*
8.25	*	*	*	*	*	*	*	*	*	*	*	*	*	*

CT – CENTRE THICKNESS
ET – EDGE THICKNESS

Prepared by	Approved by	Page 1 of 1
SURAJ AROLKAR	YESHWANT LAWANDE	